

Live Better



YORK

FURNISHING FABRICS SINCE 1988

FOREST
DRAPERY HARDWARE



EASY
INSTALL



CORDED
CONTROL

FOREST CKS corded Systems

Heavy duty corded curtain track systems with separate internal cord channels; preventing cord sag and eliminating cord tangle.

THE WORLD
BEHIND
YOUR
CURTAINS

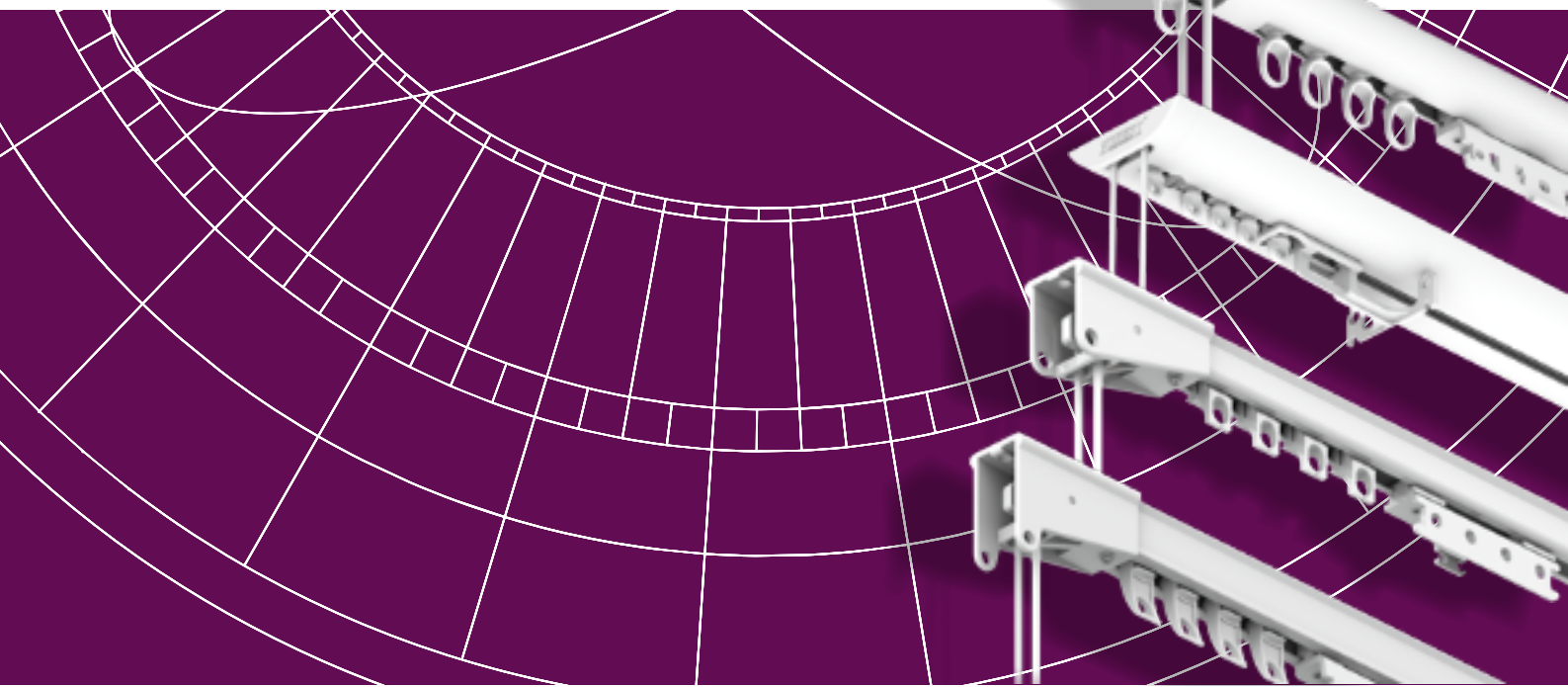

FOREST CKS® corded



PRODUCT INFORMATION

- Highly efficient cord traversing system with separate internal cord channels; preventing cord sag and eliminating cord tangle.
- Quick installation with “Smart Klick” brackets for wall and ceiling applications.
- Bendable; it can be curved and reverse curved by using a 10 cm (4”) radius or continuous curved.
- Heavy duty clickable carriers - UV protected - for smooth and easy traversing. Offset shape for straight hanging pleats.
- Can also be used for ripplefold or accordiafold drapery systems.
- Maximum fabric weight: ± 6 kg per meter (4,5 LBS per ft.). Overall max weight, 40 kg.
- Colours available: white, grey and black.
- Available lengths: 4 meter (13’1”), 5 meter (16’4”), 6 meter (19’8”),).
- Track finish: chromated powder coated with a factory applied patented dry lubricant.
- Warranty: 10 years



25
mm
(1”)

Clickable carrier



Easy installation
click - position - tighten

PROFILE

- Shown actual size 1:1
- Aluminium Extrusion
- Weight: 202 grams per meter (2.17 ounce per ft.)
- Dimensions: 14 mm x 20 mm (0,6” x 0,8”)

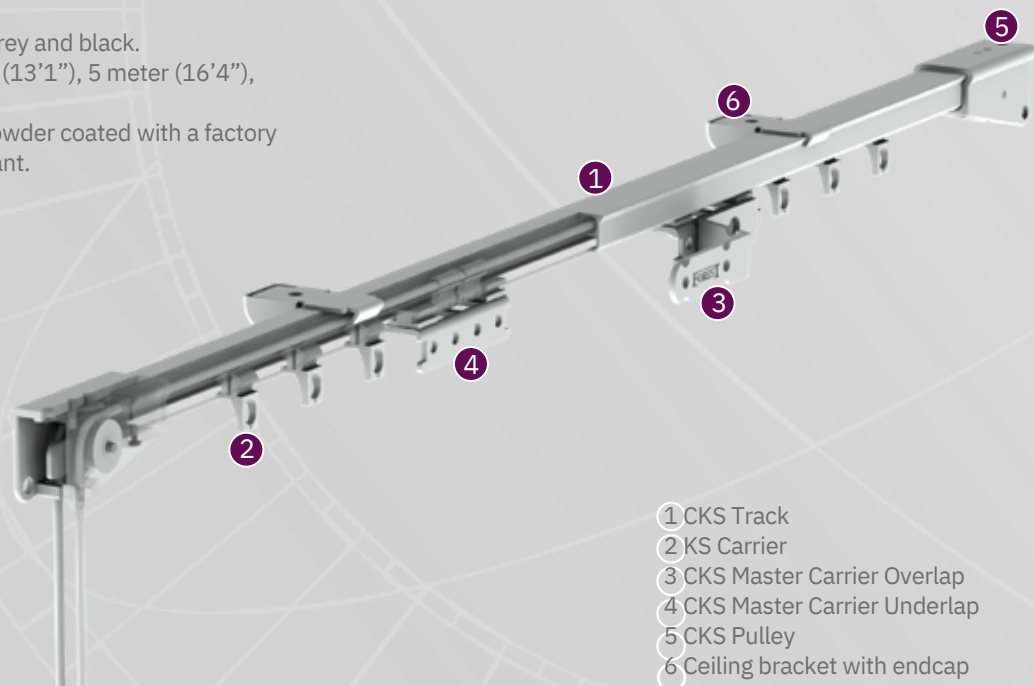
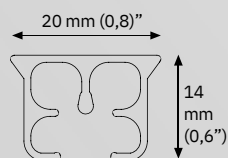

- 1 CKS Track
- 2 KS Carrier
- 3 CKS Master Carrier Overlap
- 4 CKS Master Carrier Underlap
- 5 CKS Pulley
- 6 Ceiling bracket with endcap



MOUNTING BRACKETS

Wall bracket

3,5 cm (1,4"),
6 cm (2,4")

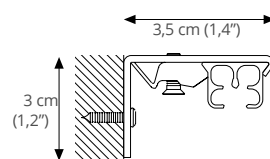

A) Min. 10 cm (4")



A) Min. 15 cm (6")



SK Ceiling Bracket

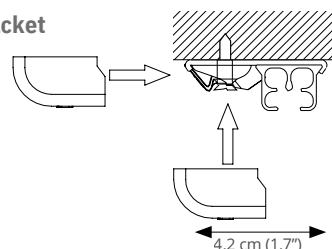

SK Wall bracket aluminium single

A) 7,5 cm (3")
B) 6,3 cm (2,5")

A) 10 cm (4")
B) 8,8 cm (3,5")

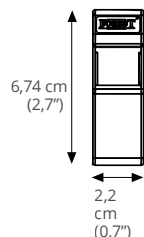
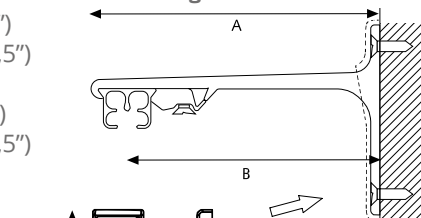

**Smart Klick Cover
Cap for Aluminium
Wall bracket**

SK Wall bracket aluminium double

A) 15 cm (6") B) 9,2 cm (3,6") C) 4,5 cm (1,8") B)
A) 20 cm (8") 9,2 cm (3,6") C) 9,5 cm (3,7")

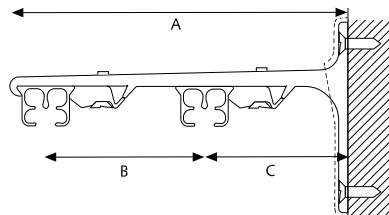

SK Wall bracket aluminium triple

25 cm (10")

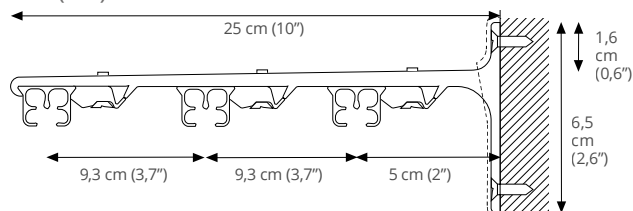

APPLICATIONS

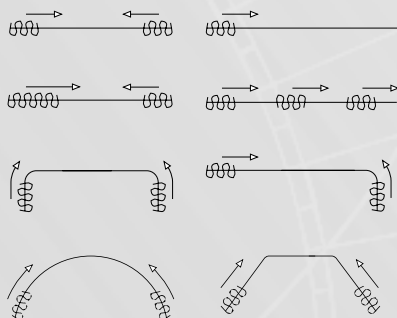





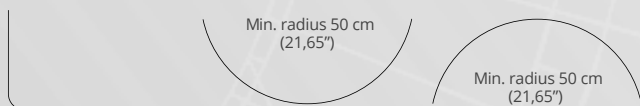

BENDING / CURVING



The track can be curved and reversed curved using a 10 cm (4") radius. Continuous curving can easily be done using the continuous curver or the electric powered bender.

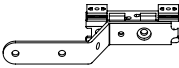
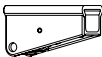

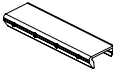





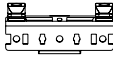

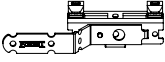
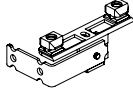
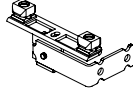
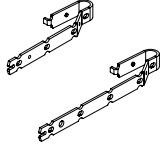
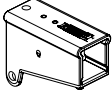
FOR USE IN

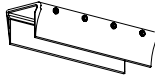

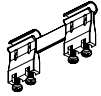



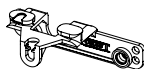
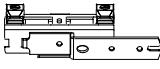
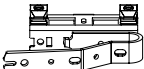

Hotels - offices - residences - boats - campers - planes or any location where an efficient cord traversing system is required.

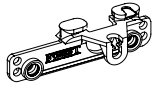
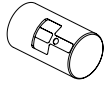
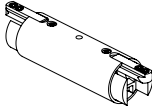

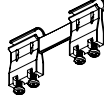

CKS corded	CCS corded		CKS TRACK+ PARTS	ARTICLE	PACKING UNIT		ART.NR
•				CKS TRACK 4 mtr. 5 mtr. 5 mtr. 5 mtr. 6 mtr.	20/bundle	white white grey black white	1501001400 1501001500 1501003500 1501006500 1501001600
•				CARRIER ASYMMETRICAL "Clickable", offset, constructed of UV resistant plastic. 10 Carriers on a break-away strip. Can be clicked in after installation. Also symmetrical carriers available.	500/box	white grey black	101000100 0 101000300 0 101000600 0
•				CKS MASTER CARRIER UNDERLAP R/L Will go through curves.	25/box	white grey black	151560100 0 151560300 0 151560600 0
•				CKS MASTER CARRIER OVERLAP R/L Will go through curves.	25/box	white grey black	151570100 0 151570300 0 151570600 0
•				CKS PULLEY Reversible, for two way draw.	25/box	white grey black	153010100 0 153010300 0 153010600 0
•				CKS END PULLEY SHORT Especially for one-way closing of the curtain.	25/box	white grey black	153010101 1 153010301 1 153010601 1
•				CKS TRACK JOINER	10/box	white grey black	101840101 0 101840301 0 101840601 0
•				CKS CORD CONNECTOR Connects cord to the CKS Master Carrier. CKS CORD Connector Half Connects cord to the CKS Master Carrier.	100/box 100/box	white black white	153030100 0 153030600 0 153031100 0
•	•			TRAVERSE CORD Polyester drapery cord designed for smooth slide, Ø 3.5 mm (0,14"), 16 ply. Suitable for CKS / CCS / CRS / DS-XL Corded	250 mtr/roll	white grey black	103040100 0 103040300 0 103040600 0

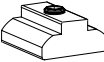

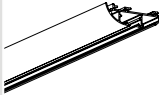

CKS corded	CCS corded		CCS TRACK+ PARTS	ARTICLE	PACKING UNIT		ART.NR
	•			CCS TRACK 3.66 mtr. 4.27 mtr. 4.88 mtr. 6.10 mtr. 6.10 mtr. 6.10 mtr.	10/bundle	white white white white grey black	300100136 6 300100142 7 300100148 8 300100161 0 300100361 0
	•			CCS CARRIER SMALL Contract click carrier patented, clickable. UV-resistant POM plastic.	250/box	white	300100661 0 3510101000
	•			FMS/CCS/MRS WHEEL CARRIER The wheel carrier goes smoothly over a splice.	100/box	white	5210101002
	•			CCS CORD MASTER CARRIER R/L UNDERLAP Multifunctional - reversible arm - will go through curves.	15/box	white grey gold black	301560100 0 301560300 0 301560200 0 301560600 0

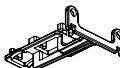

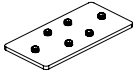

				CCS CORD MASTER CARRIER R/L OVERLAP Multifunctional - reversible arm - will go through curves, will also fit stiffeners and cord connector.	15/box	white grey gold black	301570100 0 301570300 0 301570200 0
				EASYFLEX MASTER CARRIER 90 DEGREE LEFT for center draw	15/box	white black	301570600 0 481535109
				EASYFLEX MASTER CARRIER 90 DEGREE RIGHT for center draw	15/box	white black	481545109 0 481545609 0
				PROLONGED ARM FOR MASTER CARRIER 150 mm long 150 mm long 150 mm long 150 mm long Click On 150 mm long Click On 200 mm long Click On	15/box	white grey black white black white	301600100 0 301600300 0 301600600 0 950000101
				CCS PULLEY Voor middenluitend pakket	25/box	white grey black	0 850000601 950000102 0
				INSIDE WALL BRACKET For additional support anywhere the pulley meets the wall.	25/box		3022301000 303010100 0 203010300
				END PULLEY SMALL Reversible, for non-stacking side on one way draw.	25/box	white grey black	303020100 0 303010600 0 003020300 0 303020600 0
				CCS RAIL CONNECTOR	10/box	white grey black	0 251840100 0 251840300 0 251840600 0
				CCS CORD CONNECTOR Connects cord to the CCS master carrier.	100/box	white grey black	0 303030100 0 303030300 0 303030600 0
				CCS DOUBLE CORD CONNECTOR Connects cord to the CCS master carrier.	20/box	white grey black	0 303030101 0 303030301 0 303030601 0
				TRAVERSE CORD Polyester drapery cord designed for strong smooth slide, Ø 3.5 mm (0,14"), 16 ply. Suitable for CKS/CCS/CRS/DS-XL Corded DS-XL Corded	250 mtr/roll	white grey black	0 103040100 0 103040300 0 103040600 0





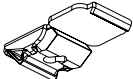
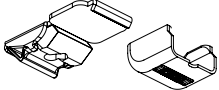
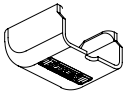
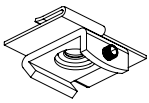
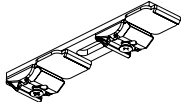

CKS corded	CCS corded		CRS TRACK+ PARTS	ARTICLE	PACKING UNIT		ART.NR
				CRS CHANNEL ROD CORDED Ø 28 mm (1.1") Extruded aluminium, chromated, powder coated incl. inlay strip	5.80 mtr/tube	white gold-an inox-an inox-pc antique-pc anthracite-pc chrome	5811281580-PC 5811282580 5811283580 5811283580-PC 5811289580-PC 5811286580-PC 5701287520
				CRS CARRIER ROUND	500/box	white grey black	5810101000 5810103000 5810106000
				EASYFOLD PLASTIC MASTER UNDERLAP	25/box	white grey black transparent	481520101 0 481520301 0 481520601 0
				FMS MASTER CARRIER UNDERLAP Multifunctional - arm is reversible for Click on stiffner	15/box	white grey black	481520100 0 521580101
				FMS MASTER CARRIER OVERLAP Multifunctional - arm is reversible for Click on stiffner	15/box	white grey black	521590101 0 521590301 0 521580601 521590601 0

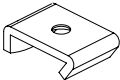
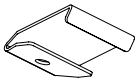
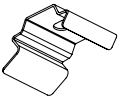

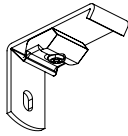
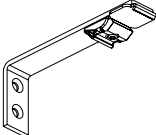
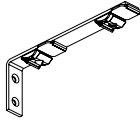

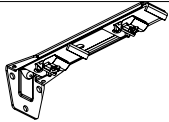
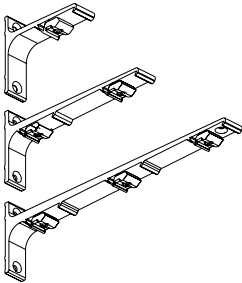

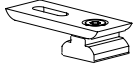
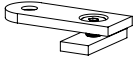

CKS corded	CCS corded		CRS TRACK+ PARTS	ARTICLE	PACKING UNIT		ART.NR
				EASYFOLD PLASTIC MASTER STRAIGHT/ OVERLAP	25/box	white grey black transparent	4815101010 4815103010 4815106010 4815101000
				CRS CORDED END PULLEY COMPLETE	2/box	white gold inox-an inox-pc antique-pc taupe-pc anthracite-pc	6130201001-PC 6130202001 6130203001 6130203001-PC 6130209001-PC 6130204001-PC 6130206001-PC
•				CRS CORDED CENTRE PULLEY COMPLETE	2/box	white inox-an inox-pc antique-pc taupe-pc anthracite-pc	6130251001-PC 6130253001 6130253001-PC 6130259001-PC 6130254001-PC 6130256001-PC
•				CRS RAIL CONNECTOR (6 CM)	10/box		5815200006
•				CRS CORNER CONNECTOR (5 CM)	10/box		5815200007
	•			CCS CORD CONNECTOR	100/box	white grey black	303030100 0 303030300 0 303030600 0
	•			CCS DOUBLE CORD CONNECTOR	100/box	white grey black	303030101 0 303030301 0 303030601 0
•	•			TRAVERSE CORD Polyester drapery cord designed for smooth slide, Ø 3.5 mm (0,14"), 16 ply. Suitable for CKS / CCS / CRS / DS-XL Corded	250 mtr/roll	white grey black	103040100 0 103040300 0 103040600 0
•				CRS METAL ENDSTOP WITH SCREW for 20 mm (0,8") for 28 mm (1.1")	100/box		5816101000 5816101001
•				CRS METAL ENDSTOP WITH SCREW-EYE for 20 mm (0,8") for 28 mm (1.1") Long, with ball bearings	100/box		581610200 0 581610200 1

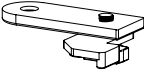



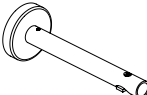
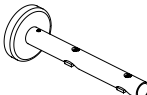
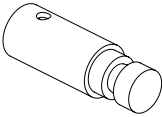
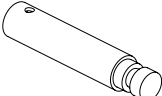

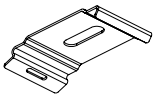

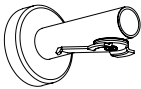
CKS corded	CCS corded			ARTICLE	PACKING UNIT		ART.NR
				DS-XL RAIL, 6 mtr (19"8")	24 mtr/bundle	white grey anthracite	391610160 0 391610360 0 391610660 0
				ECONOMY CARRIER SMALL	500/box	white black	391010100 0 391010600 0
				EASYFLEX PLASTIC MASTER CARRIER 90 DEGREE	15/box	white grey black	391670100 0 391670300 0 391670600 0
				DS-XL ENDCAP CORDED	20/box	white grey black	391620100 0 391620500 0 391620600 0

					DS-XL TRACK CONNECTOR STRAIGHT	10/box		3916401000
					DS-XL CORD CONNECTOR	100/box	white black	153030100 0 153030600 0
	•	•	•		TRAVERSE CORD Polyester drapery cord designed for smooth slide, Ø 3.5 mm (0,14"),16 ply. Suitable for CKS / CCS / CRS / DS-XL Corded	250 mtr/roll	white grey black	103040100 0 103040300 0 103040600 0
	•		•		DS-XL END STOP	100/box		3916001000

CKS corded	CCS corded			MOUNTING	ARTICLE	PACKING UNIT		ART.NR
•	•				CEILING BRACKET Slides onto the track, powder coated. Regular duty	100/box	white grey black beige	1018001000 1018003000 1018006000 1018012000
•	•				CEILING BRACKET WITH SLOT Slides onto the track, powder coated. Regular duty Slotted support makes fixing curtain track easier.	100/box	white grey black creme beige	1018101000 1018103000 1018106000 1018111000 1018112000
•					SMART KLICK CEILING BRACKET Powder coated, "klicks" onto track. Attach with VK-4 mm screw.	100/box	white grey black	1018201000 1018203000 1018206000
•					SMART KLICK CEILING BRACKET INCL. COVER CAP	100/box	white grey black	1018201001 1018203001 1018206001
•					COVER CAP FOR SMART KLICK BRACKETS Suitable for Smart Klick Wall-and Ceiling bracket.	100/box	white grey black anthracite	1019201000 1019203000 1019206000 1019206600
•					FALSE CEILING BRACKET (METAL) For installation on to a suspended ceiling. The track can be fixed in any angle.	25/box		4519001000
•	•				SMART KLICK DOUBLE CEILING BRACKET LARGE Distance between two tracks: 90 mm (3,5")	30/box	white	1018601000
•					SMART KLICK DOUBLE CEILING BRACKET SHORT Distance between two tracks: 45 mm (1,8")			1018611000
•					FSS MOUNTING BRACKET For concealed installation or ceiling installation in narrow spaces. Heavy Duty.	100/box		7160001000
•					KS CEILING SPLICE BRACKET For ceiling installation only, powder coated.	50/box	white grey black	1018501000 1018503000 1018506000
•					KS KLICK-ON CEILING BRACKET WHITE For concealed installation without visible brackets, light weight use only.	100/box	white grey black	1018301000 1018303000 1018306000

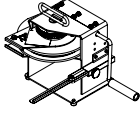
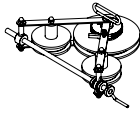
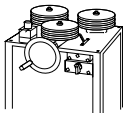
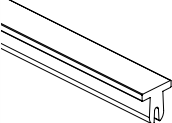
CKS covered	CCS covered			MOUNTING	ARTICLE	PACKING UNIT		ART.NR
					SMART KLICK WALL BRACKET 3,5 cm "Klicks onto track, powder coated. One screw attachment. For light weight use only.	50/box	white grey black	1020201035 1020203035 1020206035
•	•				SMART KLICK WALL BRACKET 6 cm "Klicks onto track, powder coated. One screw attachment. For light weight use only.		white grey black	1020201060 1020203060 1020206060
					SMART KLICK WALL BRACKET 7,5 cm "Klicks onto track, powder coated. One screw attachment. For light weight use only.		white grey black	1020201075 1020203075 1020206075
•	•				KS SMART KLICK WALL BRACKET 10 cm	20/box	white	1020201100
					KS SMART KLICK WALL BRACKET 12,5 cm	20/box	grey white	1020203100 1020201125
					KS SMART KLICK WALL BRACKET 15 cm	15/box	grey white	1020203125 1020201150
					KS SMART KLICK WALL BRACKET 20 cm	15/box	grey white	1020203150 1020201200
					KS SMART KLICK WALL BRACKET 25 cm	10/box	grey white	1020203200 1020201250
					KS SMART KLICK WALL BRACKET 30 cm	10/box	grey white grey	1020203250 1020201300 1020203300
•					KS SMART KLICK WALL BRACKET DOUBLE For light weight use only.	15/box	15 cm 20 cm	1020601150 1020601200
•						KS ADJUSTABLE WALL BRACKET, SINGLE	100/box	white grey
•						KS ADJUSTABLE WALL BRACKET, DOUBLE	50/box	white grey
•						ALUMINIUM SK WALL BRACKET 7,5 CM SINGLE. "Klicks onto track, powder coated.	20/box	white grey black
•				ALUMINIUM SK AFSTANDSTEUN 10 cm ENKEL. "Klicks onto track, powder coated.		20/box	white grey black	1020301100 1020303100 1020306100
•	•			ALUMINIUM SK AFSTANDSTEUN 15 cm DUBBEL. "Klicks onto track, powder coated.		15/box	white grey black	1020301150 1020303150 1020306150
				KS ALUMINIUM SK AFSTANDSTEUN 20 cm DUBBEL. "Klicks onto track, powder coated.		15/box	white grey black	1020301200 1020303200 1020306200
				ALUMINIUM SK AFSTANDSTEUN 25 cm TRIPLE. "Klicks onto track, powder coated.		10/box	white grey black	1020301250 1020303250 1020305250
•	•				SMART KLICK COVER CAP ALUMINIUM BRACKET UNIVERSAL	50/box	white grey black	1021301000 1021303000 1021306000
					CRS CEILING BRACKET Ø 20/28 MM with slot	100/box	aluminium	5818003000
					CRS CEILING BRACKET Ø 20/28 MM with hole	100/box	white inox	581800310 1 581800310 3
					MRS CEILING BRACKET SMALL, 1,5 CM	4/box	chrome	5718407050

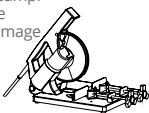
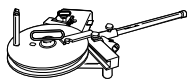
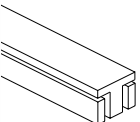
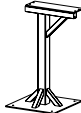
CKS corded	CCS corded		MOUNTING	ARTICLE	PACKING UNIT	ART.NR
				CRS SWIVEL FOR 28 MM ROD	100/box	5863001000
				CRS CEILING SUSPENSION BRACKET 4 CM (1.57") Ø 20/28 MM	2/box	white 5818112000 gold 5818122000 inox-an 5818132000 inox-pc 5818132000-PC black 5818162000-PC antique-pc 5818192000-PC anthracite-pc 5818152000-PC chrome 5818012028
				CRS CEILING SUSPENSION BRACKET 5 CM (1.96") Ø 20/28 MM	2/box	white 5818112028 gold 5818122028 inox-an 5818132028 inox-pc 5818132028-PC antique-pc 5818192028-PC
				CRS WALL BRACKET SINGLE 8 CM (3.15") Ø 28 MM	2/box	white 5820080128 gold 5820080228 inox-an 5820080328 inox-pc 5820080328-PC black 5820080628-PC antique-pc 5820080928-PC taupe-pc 5820080428-PC anthracite-pc 5820080528-PC chrome 5820080728
				CRS WALL BRACKET SINGLE 12 CM (4.72") Ø 28 MM	2/box	white 5820120128 gold 5820120228 inox-an 5820120328 inox-pc 5820120328-PC black 5820120628-PC antique-pc 5820120928-PC taupe-pc 5820120428-PC anthracite-pc 5820120528-PC chrome 5820120728
				CRS WALL BRACKET SINGLE 16 CM (6.29") Ø 28 MM	2/box	white 5820160128 gold 5820160228 inox-an 5820160328 inox-pc 5820160328-PC black 5820160628-PC antique-pc 5820160928-PC taupe-pc 5820160428-PC anthracite-pc 5820160528-PC
				CRS WALL BRACKET DOUBLE 16 CM (6.29") Ø 28 MM	2/box	white 5822160128 gold 5822160228 inox-an 5822160328 inox-pc 5822160328-PC black 5822160628-PC antique-pc 5822160928-PC taupe-pc 5822160428-PC anthracite-pc 5822160528-PC
				CRS WALL BRACKET EXTENSION 4 CM	10/box	white 5815201030 gold 5815202030 inox-an 5815203030 inox-pc 5815203030-PC black 5815206030-PC antique-pc 5815209030-PC anthracite-pc 5815205030-PC chrome 5715107040
				CRS WALL BRACKET EXTENSION 8 CM		gold 5815102020 inox-an 5815103020 inox-pc 5815103020-PC black 5815106020-PC antique-pc 5815109020-PC chrome 5715107080
				CRS ADJUSTABLE BRACKET EXTENSION	10/box	white 5815101070 inox-an 5815103070 inox-pc 5815103070-PC black 5815106070-PC antique-pc 5815109070-PC
				DS-XL KLICK CEILING BRACKET	100/box	3918301000
				DS-XL CEILING SWIVEL BRACKET	100/box	white 381820023 anthracite 0 381820523 0
				DS-XL WALL BRACKET 9 CM	5/box	white 382000101 anthracite 8 382000501 8

CKS corded	CCS corded			BUIGONDERDELEN EN OVERIGE ITEMS	ARTICLE	PACKING UNIT	ART.NR
•	•	•			TENSION PULLEY White	25/box	1030501000
•					ASSEMBLY TOOL FOR CORD CONNECTOR	1/each	9510000027
•	•	•			CORD/CHAIN WALL MOUNT SAFETY BOX SINGLE	25/box	3645702000
•					CORD/CHAIN WEIGHT DESIGN 110 GR WIT	10/box	white grey black 303070100 0 303070300 0 303070600 0
•	•	•			CHANNEL ROD LUBRICANT SPRAY To lubricate components during assembly.	1/each	5109020000
•					COMPACT BENDING HOUSE, FOR KS/CKS	1/box	1050000000
					CKS BENDING WHEEL ALL-IN incl. strips (60cm)		1051000000
•	•	•			CONTINUOUS CURVER Add on tool for the Compact Bending Tool. Designed to create continuous curves and arches in any radius. Includes KS bending strip. For KS and CKS Track only.	1/box	1060200000
•					ELECTRIC POWERED BENDER For creating continuous curves. Minimum radius 50 cm.	1/box	230V 110V 106050000 0 106050000 1
•	•	•			CKS REPLACEMENT BENDING STRIP For Compact Bending Tool. Length of strip: 60 cm (23")	1/each	1560100000
•		•			For Continues Curver / electric bender. Length of strip: 7 mtr. (23")		1560300000
•	•				BENDING WHEELS For electric powered bender. Complete set of 3 wheels.	1/set	106070000 0
•	•	•			ELECTRIC POWERED RAILCUTTER 230 Volt EU BLADE FOREST CUTTER NEW MODEL	1/each	256070000 0
•	•				CONTRACT BENDING TOOL For CS/CCS/FMS/CRS/MTS	1/each	2560200000
					CS/CCS/FMS Bending Wheel	1/eac	256100000
		•			CCS BENDING STRIPS, COMPLETE SET For CCS track, length: 90 cm. FOR CCS ELECTRIC POWERED BENDER. Length 7 meter (23').	h 1/set 1/each	0 850000000 8500000010 2
	•				BENDING STANDARD Standard for Contract bending tool 28 mm	1/each	2560800000
	•				BENDING WHEELS For Electric Powered Bender. Complete set of 3 wheels only for CS en CCS rail.	1/set	2560700000